

2018

LOC-LINE®

THE ORIGINAL MODULAR HOSE SYSTEM



MADE IN
USA 



LOC-LINE®

The original modular hose system.

Loc-Line® was the answer to an age old problem specific to the machine tool industry: How to easily apply liquid coolant at the point of contact with the cutting tool and the target metal.

The design was simple and elegant. A ball and socket assembly with just enough friction to create a hose that offered unlimited positioning, full coolant flow, would not fatigue, stayed in position and could be customized to the job. Loc-Line was and still is the number one coolant delivery answer for machinists across the globe. Over the years, the adjustable hose concept has expanded way beyond its first task of coolant delivery.

The Loc-Line® System: Endless Combinations, Outstanding Results

Continued growth has seen the use of Loc-Line expanding into the electronic, scientific, graphic arts and woodworking industries. Almost any situation that requires precise yet adjustable directional flow of fluid, air, vacuum and third arm positioning will find Loc-Line to be the perfect solution. With four hose diameters; 1/4", 1/2", 3/4" and 2½" to accommodate many applications and environments, our customers have become as varied as our hose combinations.



CONTENTS

THE LOC-LINE® SYSTEM	2
1/4-INCH SYSTEM	4
1/2-INCH SYSTEM	8
3/4-INCH SYSTEM	11
QUICK-SET™ SHIELDS	12
2 1/2-INCH SYSTEM	12
HIGH PRESSURE TURRET NOZZLES	14
ACID RESISTANT SYSTEM	16
TEFEN™ FITTINGS	17
TECHNICAL INFORMATION	18

1/4-INCH SYSTEM

KITS

1/4" HOSE KIT

40413

- (2) 5/8" Long Segments
- (1) 1/4" Round Nozzle
- (1) 1/8" Round Nozzle
- (1) 1/16" Round Nozzle
- (1) 1/4" NPT Connector
- (1) 1/8" NPT Connector

• Assembled Length = 13"



1/4" FLARED TUBING REPLACEMENT PACK

40452

- (8) 5/8" Long Segments
- (1) 1" Flare Nozzle
- (4) 3/8" Flare Nut Adapters
- (4) 1/8" Round Nozzles
- (4) 1/4" Round Nozzles

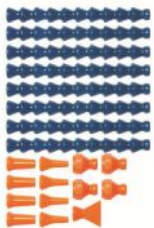

HAAS LATHE ADAPTER KIT

40475

- (4) Haas Short Adapters
- (4) Haas 2" Adapters
- (2) Flat 5-Hole Nozzles
- (2) 1/8" 90° Nozzles
- (2) 1/4" 90° Nozzles
- (2) 1/8" Round Nozzles
- (2) 1/4" Round Nozzles
- (2) Straight Flow Nozzles
- (4) Element Clamps w/ screws
- (8) Elements
- (1) 1/4" Assembly Pliers



15 MM LATHE ADAPTER KIT

40476

- (4) 15 mm Short Adapters
- (4) 15 mm x 2" Adapters
- (2) Flat 5 Hole Nozzles
- (2) Flat Slot 60 Nozzles
- (2) 1/8" 90° Nozzles
- (2) 1/4" 90° Nozzles
- (2) 1/8" Round Nozzles
- (2) 1/4" Round Nozzles
- (2) Straight Flow Nozzles
- (4) Element Clamps w/ screws
- (8) Elements
- (1) 1/4" Assembly Pliers



1/4" EXTENDED ELBOW KIT

40472

- (4) Extended Elbows
- (4) Element Clamps w/ screws
- (1) 1/8" NPT Connector
- (1) 1/4" NPT Connector
- (1) 1/16" Round Nozzle
- (1) 1/8" Round Nozzle
- (1) 1/4" Round Nozzle



1/4" MIXED ELEMENT KIT

40473

- (2) Extended Elbows
- (2) Extended Elements
- (4) Element Clamps w/ screws
- (1) 1/8" NPT Connector
- (1) 1/4" NPT Connector
- (1) 1/16" Round Nozzle
- (1) 1/8" Round Nozzle
- (1) 1/4" Round Nozzle



1/4" EXTENDED ELBOWS WITH CLAMPS

40474

- (4) Extended Elbows
- (4) Element Clamps w/ screws



1/4" EXTENDED ELEMENT KIT WITH CLAMPS

41475

- (4) 1/4" Extended Elements
- (4) 1/4" Element Clamps w/ screws



1/4" CIRCLE FLOW NOZZLE KIT

41479

- Assembled with:
- (15) 1/4" Side Flow Nozzles
- (1) 1/4" End Cap



Overall Length = 17.56"

1/4" PROSTREAM® NOZZLE KIT

42400

- (1) 5/8" Long Segments
- (1) ProStream® Nozzle 0.160"ø x 1.25"L
- (8) 1/4" Element Clamps w/ screws
- (1) 1/4" NPT Connector
- (1) 1/8" NPT Connector



HOSES

1/4" HOSE

41401

- (2) 5/8" Long Segments*

49420 ■ ■-BLK ■-G ■-W

- (55) Segments*, Bulk 25-ft

49419 ■ ■-BLK ■-G ■-W

- (1) 5 ft Coil

49421 ■ ■-BLK ■-G ■-W

- (1) 50 ft Coil

*1 Segment = 10 Elements



1/4" EXTENDED ELEMENT

41476

- (4) Extended Elements

49445 ■ ■-BLK ■-G

- (20) Extended Elements



1/4" EXTENDED ELBOW

41491

- (4) Extended Elbows

49457 ■ ■-BLK ■-G

- (20) Extended Elbows



CONNECTORS

1/8" NPT CONNECTOR

- 41405 (4) NPT Connectors
- 49425 (50) NPT Connectors



1/8" BSPT* CONNECTOR

- 41417 (4) BSPT Connectors
- 49437 (50) BSPT Connectors



*British Standard Pipe Thread

1/4" NPT CONNECTOR

- 41406 (4) NPT Connectors
- 49426 (50) NPT Connectors



1/4" BSPT* CONNECTOR

- 41418 (4) BSPT Connectors
- 49438 (50) BSPT Connectors



*British Standard Pipe Thread

3/8" SAE FLARE NUT ADAPTER

- 41412 (4) Flare Nut Adapters
- 49432 (20) Flare Nut Adapters



5/8 - 18 Thread

1/4" SAE FLARE NUT ADAPTER

- 41414 (4) Flare Nut Adapters
- 49434 (20) Flare Nut Adapters



7/16 - 20 Thread

15 MM "SHORT" LATHE ADAPTER

- 41492 (4) Lathe Adapters
- 49458 (20) Lathe Adapters



15 MM X 2" LATHE ADAPTER

- 41493 (4) Lathe Adapters
- 49459 (20) Lathe Adapters



HAAS "SHORT" LATHE ADAPTER

- 41494 (4) Lathe Adapters
- 49460 (20) Lathe Adapters



HAAS x 2" LATHE ADAPTER

- 41495 (4) Lathe Adapters
- 49461 (20) Lathe Adapters



NOZZLES

1/4" NOZZLE-RAMA PACK

- 41490 (20) Includes 1 nozzle from each of these packages: 41402, 41403, 41404, 41407, 41460, 41461, 41462, 41463, 41470, 41471, 41472, 41473, 41481, 41482, 41483, 41484, 41485, 41486, 41488, 41489



1/4" 90° NOZZLE KIT

- 41474 (1) 1/16" 90° Nozzle
- (1) 1/8" 90° Nozzle
- (1) 1/4" 90° Nozzle
- (1) 1/4" 90° Spray Bar Nozz



1/4" FLAT NOZZLE ASSORTMENT PACK

- 41487 (1) Flat Slot 40 Nozzle
- (1) Flat Slot 60 Nozzle
- (1) Flat 5 Hole Nozzle
- (1) Flat 7 Hole Nozzle



1/16" ROUND NOZZLE

- 41402 (4) Round Nozzles
- 49422 (50) Round Nozzles



1/8" ROUND NOZZLE

- 41403 (4) Round Nozzles
- 49423 (50) Round Nozzles



1/4" ROUND NOZZLE

- 41404 (4) Round Nozzles
- 49424 (50) Round Nozzles



1" FLARE NOZZLE

- 41407 (2) Flare Nozzles
- 49427 (20) Flare Nozzles



1" STRAIGHT FLOW NOZZLE

- 41489 (2) Straight Flow Nozzles
- 49456 (20) Straight Flow Nozzles



1/16" 90° NOZZLE

- 41470 (4) 90° Nozzles
- 49439 (20) 90° Nozzles



1/8" 90° NOZZLE

- 41471 (4) 90° Nozzles
- 49440 (20) 90° Nozzles



1/4" 90° NOZZLE

- 41472 (4) 90° Nozzles
- 49441 (20) 90° Nozzles



1/4" 90° SPRAY BAR NOZZLE

- 41473 (2) 90° Spray Bar Nozzles
- 49442 (20) 90° Spray Bar Nozzles



NOZZLES (continued)

3/32" 45° NOZZLE

- 41460 
 (4) 3/32" 45° Nozzles
 49470 
 (20) 3/32" 45° Nozzles

1/8" 45° NOZZLE

- 41461 
 (4) 1/8" 45° Nozzles
 49471 
 (20) 1/8" 45° Nozzles



3/16" 45° NOZZLE

- 41462 
 (4) 3/16" 45° Nozzles
 49472 
 (20) 3/16" 45° Nozzles



1/4" 45° NOZZLE

- 41463 
 (4) 1/4" 45° Nozzles
 49473 
 (20) 1/4" 45° Nozzles

1/4" FLAT SLOT 40 NOZZLE

- 41483 
 (4) Flat Slot Nozzles
 49451 
 (20) Flat Slot Nozzles
 0.040" Slot height

1/4" FLAT SLOT 60 NOZZLE

- 41484 
 (4) Flat Slot Nozzles
 49452 
 (20) Flat Slot Nozzles
 0.060" Slot height

1/4" FLAT 5-HOLE NOZZLE

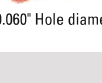
- 41485 
 (4) Flat 5-Hole Nozzles
 49453 
 (20) Flat 5-Hole Nozzles
 0.060" Hole diameter

1/4" FLAT 7-HOLE NOZZLE

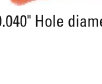
- 41486 
 (4) Flat 7-Hole Nozzles
 49454 
 (20) Flat 7-Hole Nozzles
 0.040" Hole diameter

1/4" SIDE FLOW NOZZLE

- 41478 
 (4) Side Flow Nozzles
 49443 
 (20) Side Flow Nozzles



1/4" SWIVEL NOZZLE 40

- 41481 
 (2) Swivel Nozzles
 49449 
 (20) Swivel Nozzle
 0.040" Hole diameter

1/4" SWIVEL NOZZLE 60



- 41482 
 (2) Swivel Nozzles
 49450 
 (20) Swivel Nozzles
 0.060" Hole diameter

2 1/2" SWIVEL NOZZLE 75



- 41488 
 (2) Swivel Nozzles
 49455 
 (20) Swivel Nozzles
 0.075" Hole diameter

PROSTREAM® NOZZLES



.062"Øx.50"L PROSTREAM® NOZZLE

- 41420 
 (2) ProStream Nozzles
 49480 
 (10) ProStream Nozzles



.086"Øx.50"L PROSTREAM® NOZZLE

- 41421 
 (2) ProStream Nozzles
 49481 
 (10) ProStream Nozzles



.117"Øx.50"L PROSTREAM® NOZZLE

- 41422 
 (2) ProStream Nozzles
 49482 
 (10) ProStream Nozzles



.160"Øx.50"L PROSTREAM® NOZZLE

- 41423 
 (2) ProStream Nozzles
 49483 
 (10) ProStream Nozzles



.062"Øx1.25"L PROSTREAM® NOZZLE

- 41424 
 (2) ProStream Nozzles
 49484 
 (10) ProStream Nozzles



.086"Øx1.25"L PROSTREAM® NOZZLE

- 41425 
 (2) ProStream Nozzles
 49485 
 (10) ProStream Nozzles

.117"Øx1.25"L PROSTREAM® NOZZLE

- 41426 
 (2) ProStream Nozzles
 49486 
 (10) ProStream Nozzles

.169"Øx1.25"L PROSTREAM® NOZZLE

- 41427 
 (2) ProStream Nozzles
 49487 
 (10) ProStream Nozzles

BALL ADAPTERS

10 MMØ X 1/4" LOC-LINE® BALL ADAPTER

- 41740 (2) Brass Ball Adapters 
 49740 (10) Brass Ball Adapters

12 MMØ X 1/4" LOC-LINE® BALL ADAPTER

- 41741 (2) Brass Ball Adapters 
 49741 (10) Brass Ball Adapters

14 MMØ X 1/4" LOC-LINE® BALL ADAPTER

- 41743 (2) Brass Ball Adapters 
 49743 (10) Brass Ball Adapters

15 MMØ X 1/4" LOC-LINE® BALL ADAPTER

- 41742 (2) Brass Ball Adapters 
 49742 (10) Brass Ball Adapters

12 MMØ X 1/8" NPT BRASS BALL ADAPTER

- 41498 (2) Brass Ball Adapters 
 49493 (10) Brass Ball Adapters

14 MMØ X 1/8" NPT BRASS BALL ADAPTER



- 41497 (2) Brass Ball Adapters 
 49495 (10) Brass Ball Adapters

15 MMØ X 1/8" NPT BRASS BALL ADAPTER

- 41496 (2) Brass Ball Adapters 
 49496 (10) Brass Ball Adapters

VALVES

1/4" MALE NPT VALVE

- 21192**  (2) Male NPT Valves
- 29452**  **BLK** **G** (10) Male NPT Valves





1/4" IN-LINE VALVE

- 21194**  (2) In-Line Valves
- 29454**  **BLK** **G** (10) In-Line Valves



1/4" FEMALE NPT VALVE

- 21193**  (2) Female NPT Valves
- 29453**  **BLK** **G** (10) Female NPT Valves



1/4" IN-LINE CHECK VALVE

- 21191**  (2) Check Valves
- 29451**  **BLK** **G** (10) Check Valves



ACCESSORIES

1/4" ELEMENT CLAMP

- 41477**  (4) Element Clamps w/ screws
- 49446**  **BLK** **G** (20) Element Clamps w/ screws



1/4" SOCKET X 1/8" FNPT

- 41411**  (4) 1/4" Socket X 1/8" FNPT
- 49431**  **BLK** **G** (20) 1/4" Socket X 1/8" FNPT





1/4" END CAP

- 41480**  (4) End Caps
- 49447**  **BLK** **G** (20) End Caps



1/4" Y FITTING

- 41408**  (2) Y Fittings
- 49428**  **BLK** **G** (20) Y Fittings





1/4" ELBOW FITTING

- 41415**  (2) Elbow Fittings
- 49435**  **BLK** **G** (20) Elbow Fittings



1/4" BRASS HOSE BARB

- 40488**  (4) Brass Hose Barbs
- 49488**  (10) Brass Hose Barbs





1/4" DOUBLE SOCKET

- 41409**  (4) Double Sockets
- 49429**  **BLK** **G** (20) Double Sockets





1/4" T FITTING

- 41416**  (2) T Fittings
- 49436**  **BLK** **G** (20) T Fittings



1/4" HOSE ASSEMBLY PLIERS

- 78001**  (1) 1/4" Pliers
- 78003**  (1) 1/4" Pliers
- (1) 1/2" Pliers



* 1/4" Assembly pliers will not assemble part numbers 41411 or 49431

MANIFOLDS

MAGNETIC BASE MANIFOLD

- 40400**  (1) Magnetic Base Manifold
- (3) 1/4" Plugs
- (1) 1/4" Barb Fitting



25 LB. Holding Force

MAGNETIC BASE MANIFOLD KIT

- 40463**  (2) 5 3/4" Long Segments
- (1) 1/4" MNPT Valve
- (1) 1" Flare Nozzle
- (1) 1/4" Round Nozzle
- (1) 1/8" Round Nozzle
- (1) 1/16" Round Nozzle
- (1) Mag. Base Manifold
- (3) 1/4" Plugs
- (1) 1/4" Barb Fitting



MAGNETIC BASE MANIFOLD SUPER KIT

- 40480**  (8) 5 3/4" Long Segments
- (5) 1/4" MNPT Valves
- (2) 1" Flare Nozzles
- (2) 1/4" Round Nozzles
- (2) 1/8" Round Nozzles
- (2) 1/16" Round Nozzles
- (1) Mag. Base Manifold
- (3) 1/4" Plugs
- (1) 1/4" Barb Fitting

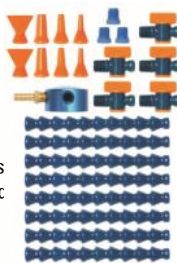

1/4" MODULAR MANIFOLD BRACKET

- 21195**  (2) Brackets



1/4" MODULAR MANIFOLD

- 21199**  (3) 1/4" T Fittings
- (1) 1/4" Elbow Fitting
- (1) 1/4" Manifold Bracket
- (3) Mounting Screws



1/4" TOTAL FLOW CONTROL MANIFOLD

- 21198**  (1) 1/4" Modular Manifold
- (5) 1/4" In-Line Valves

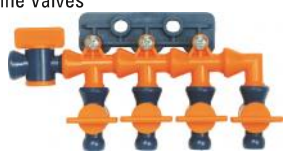

1/2-INCH SYSTEM

KITS

1/2" HOSE KIT

50813

- (2) 5/2" Long Segments
- (1) 1/4" Round Nozzle
- (1) 3/8" Round Nozzle
- (1) 1/2" Round Nozzle
- (1) 3/8" NPT Connector
- (1) 1/2" NPT Connector

• Assembled Length = 13"



1/2" MIXED ELEMENT KIT

50873

- (1) 3/8" NPT Connector
- (1) 1/2" NPT Connector
- (1) 1/4" Round Nozzle
- (1) 3/8" Round Nozzle
- (1) 1/2" Round Nozzle
- (2) Extended Elbows
- (2) Extended Elements
- (4) Element Clamps w/ screws



1/2" EXTENDED ELBOWS WITH CLAMPS

50874

- (4) Extended Elbow
- (4) Element Clamps w/ screws



1/2" EXTENDED ELEMENT KIT W/ CLAMPS

51835

- (4) 1/2" Extended Elements
- (4) Element Clamps w/ screws



1/2" EXTENDED ELBOW KIT

50872

- (1) 3/8" NPT Connector
- (1) 1/2" NPT Connector
- (1) 1/4" Round Nozzle
- (1) 3/8" Round Nozzle
- (1) 1/2" Round Nozzle
- (4) Extended Elbows
- (4) Element Clamps w/ screws



1/2" CIRCLE FLOW NOZZLE KIT

51837

- Assembled with (15) 1/2" Side Flow Nozzles
- (1) 1/2" End Cap

• Overall Length = 24.375"



HOSES

1/2" HOSE

51801

- (2) 5/2" Long Segments

59860 ■-BLK ■-G □-W

(59) Segments, Bulk 25 ft

59859 ■-BLK ■-G □-W

(1) 5 ft Coil

59861 ■-BLK ■-G □-W

(1) 50 ft Coil

• 1 Segment = 6 Elements



1/2" EXTENDED ELEMENT

51833

- (4) Extended Elements

59883 ■-BLK ■-G

(20) Extended Elements



1/2" EXTENDED ELBOW

51896

- (4) Extended Elbows

59899 ■-BLK ■-G

(20) Extended Elbows



CONNECTORS

3/8" NPT CONNECTOR

51804

- (4) NPT Connectors

59864 ■-BLK ■-G □-W

(50) NPT Connectors



3/8" BSPT* CONNECTOR

51826

- (4) BSPT Connectors

59876 ■-BLK ■-G

(50) BSPT Connectors

* British Standard Pipe Thread



1/2" BSPT* CONNECTOR

51827

- (4) BSPT Connectors

59877 ■-BLK ■-G

(50) BSPT Connectors

* British Standard Pipe Thread



1/2" NPT CONNECTOR

51805

- (4) NPT Connectors

59865 ■-BLK ■-G □-W

(50) NPT Connectors



3/8" SAE FLARE NUT ADAPTER

51823

- (4) Flare Nut Adapters

59873 ■-BLK ■-G

(20) Flare Nut Adapters



5/8 - 18 Thread

NOZZLES

1/2" NOZZLE-RAMA PACK

51849 
 (16) Includes 1 nozzle from each of these packages:
 51802, 51803, 51806, 51807, 51809, 51828, 51829, 51830, 51831, 51840, 51841 51842, 51843, 51845, 51847, 51848

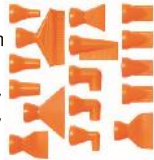

1/2" 90° NOZZLE KIT

51832 
 (1) 1/4" 90° Nozzle
 (1) 3/8" 90° Nozzle
 (1) 1/2" 90° Nozzle
 (1) 1/2" 90° Spray Bar Nozzle









1/2" FLAT NOZZLE ASSORTMENT

51844 
 (1) Flat Slot 80 Nozzle
 (1) Flat Slot 125 Nozzle
 (1) Flat 5-Hole Nozzle
 (1) Flat 7-Hole Nozzle









1/4" ROUND NOZZLE FOR 1/2"

51806 
 (4) Round Nozzles
59866     
 (50) Round Nozzles









3/8" ROUND NOZZLE

51802 
 (4) Round Nozzles
59862     
 (50) Round Nozzles







1/2" ROUND NOZZLE

51803 
 (4) Round Nozzles
59863     
 (50) Round Nozzles







1/4" 90° NOZZLE

51828 
 (4) 90° Nozzles
59878    
 (20) 90° Nozzles





3/8" 90° NOZZLE

51829 
 (4) 90° Nozzles
59879    
 (20) 90° Nozzles



1/2" 90° NOZZLE

51830 
 (4) 90° Nozzles
59880   
 (20) 90° Nozzles



1/2" 90° SPRAY BAR NOZZLE

51831 
 (2) 90° Spray Bar Nozzles
59881   
 (20) 90° Spray Bar Nozzles





1/4" FLARE NOZZLE

51807 
 (2) Flare Nozzles
59867   
 (20) Flare Nozzles







2 1/2" FLARE NOZZLE

51809 
 (2) Flare Nozzles
59871   
 (20) Flare Nozzles



1/2" SIDE FLOW NOZZLE

51836 
 (4) Side Flow Nozzles
59889   
 (20) Side Flow Nozzles







2 1/2" SWIVEL NOZZLE 75 FOR 1/2"

51845 
 (2) Swivel Nozzles
59895   
 (20) Swivel Nozzles
 • .075" Hole diameter





1/4" STRAIGHT FLOW NOZZLE

51847 
 (2) Straight Flow Nozzles
59897   
 (20) Straight Flow Nozzles



1 1/4" STRAIGHT FLOW NOZZLE

51848 
 (2) Straight Flow Nozzles
59898   
 (20) Straight Flow Nozzles







1/2" FLAT SLOT 80 NOZZLE

51840 
 (4) Flat Slot Nozzles
59890    
 (20) Flat Slot Nozzles
 • .080" Slot height







1/2" FLAT SLOT 125 NOZZLE

51841 
 (4) Flat Slot Nozzles
59891    
 (20) Flat Slot Nozzles
 • .125" Slot height







1/2" FLAT 5-HOLE NOZZLE

51842 
 (4) Flat 5-Hole Nozzles
59892    
 (20) Flat 5-Hole Nozzles
 • .125" Hole diameter



1/2" FLAT 7 HOLE NOZZLE

51843 
 (4) Flat 7-Hole Nozzles
59893    
 (20) Flat 7-Hole Nozzles
 • .080" Hole diameter



VALVES

1/2" MALE NPT VALVE

- 32092** ■
 (2) Male NPT Valves
39852 ■ ■-BLK ■-G
 (10) Male NPT Valves



1/2" IN-LINE VALVE

- 32094** ■
 (2) In-Line Valves
39854 ■ ■-BLK ■-G
 (10) In-Line Valves



1/2" IN-LINE CHECK VALVE

- 32091** ■
 (2) Check Valves
39851 ■ ■-BLK ■-G
 (10) Check Valves



1/2" FEMALE NPT VALVE

- 32093** ■
 (2) Female NPT Valves
39853 ■ ■-BLK ■-G
 (10) Female NPT Valves



ACCESSORIES

1/2" ELEMENT CLAMP

- 51834** ■
 (4) Element Clamps
 w/ screws
59884 ■ ■-BLK ■-G
 (20) Element Clamps
 w/ screws



1/2" END CAP

- 51838** ■
 (4) End Caps
59885 ■ ■-BLK ■-G
 (20) End Caps



1/2" DOUBLE SOCKET

- 51811** ■
 (4) Double Sockets
59872 ■ ■-BLK ■-G
 (20) Double Sockets



1/2" ELBOW FITTING

- 51824** ■
 (2) Elbow Fittings
59874 ■ ■-BLK ■-G
 (20) Elbow Fittings



1/2" T FITTING

- 51825** ■
 (2) T Fittings
59875 ■ ■-BLK ■-G
 (20) T Fittings



1/2" MAGNETIC BASE

- 51846** ■ ■-BLK ■-G
 (1) Magnetic Base
 • 60# holding force



1/2" Y FITTING

- 51808** ■
 (2) Y Fittings
59868 ■ ■-BLK ■-G
 (20) Y Fittings



1/2" TO 1/4" Y REDUCER

- 51822** ■
 (2) Y Reducers
59870 ■ ■-BLK ■-G
 (20) Y Reducers



1/2" TO 1/4" ADAPTER

- 51821** ■
 (2) Adapters
59869 ■ ■-BLK ■-G
 (20) Adapters



1/2" FIXED MOUNT

- 51895** ■
 (2) Fixed Mounts
59896 ■ ■-BLK ■-G
 (20) Fixed Mounts



• Mounts with 1/4" bolt, not included

1/2" HOSE ASSEMBLY PLIERS

- 78002** ■
 (1) 1/2" pliers
78003 ■
 (1) 1/4" pliers
 (1) 1/2" pliers



MANIFOLDS

1/2" MODULAR MANIFOLD

- 32099**
 (3) 1/2" T Fittings
 (1) 1/2" Elbow Fitting
 (1) 1/2" Manifold
 Bracket
 (3) Mounting Screws



1/2" TOTAL FLOW CONTROL MANIFOLD

- 32098**
 (1) 1/2" Modular
 Manifold
 (5) 1/2" In-Line
 Valves



1/2" MODULAR MANIFOLD BRACKET

- 32095** ■
 (2) Brackets



3/4-INCH SYSTEM

LOC-LINE®

KIT

3/4" HOSE KIT

60513

- (2) 5 3/4" Long Segments
- (1) 5/8" Round Nozzle
- (1) 3/4" Round Nozzle
- (1) 3/4" NPT Connector

• Assembled Length = 14"



HOSES

3/4" HOSE

61501

- (2) 5 3/4" Long Segments

69539 ■ ■-BLK ■-G

- (1) 5 ft Coil

69540 ■ ■-BLK ■-G

- (54) Segments, Bulk 25 ft

69541 ■ ■-BLK ■-G

- (1) 50 ft Coil

• 1 Segment = 6 Elements



CONNECTORS

3/4" NPT CONNECTOR

61505 ■

- (4) NPT Connectors

69545 ■ ■-BLK ■-G

- (50) NPT Connectors



3/4" BSPT* CONNECTOR

61509 ■

- (4) BSPT Connectors

69549 ■ ■-BLK ■-G

- (50) BSPT Connectors



* British Standard Pipe Thread

NOZZLES

5/8" ROUND NOZZLE

61503 ■

- (4) Round Nozzles

69543 ■ ■-BLK ■-G

- (50) Round Nozzles



3/4" ROUND NOZZLE

61502 ■

- (4) Round Nozzles

69542 ■ ■-BLK ■-G

- (50) Round Nozzles



3" FLARE NOZZLE

61507 ■

- (2) Flare Nozzles

69547 ■ ■-BLK ■-G

- (20) Flare Nozzles



VALVES

3/4" MALE NPT VALVE

61516 ■

- (2) NPT Valves

69556 ■ ■-BLK ■-G

- (10) NPT Valves



3/4" FEMALE NPT VALVE

61517 ■

- (2) Female NPT Valves

69557 ■ ■-BLK ■-G

- (10) Female NPT Valves



3/4" IN-LINE VALVE

61518 ■

- (2) In-Line Valves

69558 ■ ■-BLK ■-G

- (10) In-Line Valves



ACCESSORIES

3/4" ELEMENT CLAMP

61535 ■

- (4) Element Clamps w/ screws

69565 ■ ■-BLK ■-G

- (20) Element Clamps w/ screws



3/4" TO 1/2" Y REDUCER

61512 ■

- (2) Y Reducers

69552 ■ ■-BLK ■-G

- (20) Y Reducers



3/4" TO 1/2" ADAPTER

61508 ■

- (2) Adapters

69548 ■ ■-BLK ■-G

- (20) Adapters



3/4" DOUBLE SOCKET

61514 ■

- (4) Double Sockets

69554 ■ ■-BLK ■-G

- (20) Double Sockets



3/4" FIXED MOUNT

60533 ■

- (2) Fixed Mounts

69563 ■ ■-BLK ■-G

- (20) Fixed Mounts

• Mounts with 1/4" bolt, not included



3/4" HOSE ASSEMBLY PLIERS

78004 ■

- (1) 3/4" Pliers



• 3/4" Assembly Pliers will not assemble the 3/4" Y Fitting, the 3/4" Fixed Mount or the 3/4" Valves.

QUICK-SET™ SHIELDS

KIT

QUICK-SET SHIELD™ KIT

- 60525**
(1) 6"x8" Shield Kit
- 60526**
(1) 7½"x10" Shield Kit
- 60527**
(1) 8½"x12" Shield Kit

• All Quick-Set Shield Kits include a 14" adjustable ¾" Loc-Line® arm, magnetic base and fitting for fixed mounting.



ACCESSORIES

SHIELD MOUNTING ELBOW

- 60531** ■
(2) Mounting Elbows
- 69561** ■ ■-BLK ■-G
(20) Mounting Elbows
- Washer and screw included



REPLACEMENT SHIELD

- 60528**
(1) 6" x 8" Shield
- 60529**
(1) 7½" x 10" Shield
- 60530**
(1) 8½" x 12" Shield



¾" MAGNETIC BASE

- 60532** ■ ■-BLK ■-G
(1) Magnetic Base

- 60 lb. holding force



¾" FIXED MOUNT

- 60533** ■
(2) Fixed Mounts
- 69563** ■ ■-BLK ■-G
(20) Fixed Mounts

- Mounts with ¼" bolt, not included.



2 1/2-INCH SYSTEM

KIT

VACUUM HOSE KIT FOR 2½" SHOP VACUUM

- 80813**
(2) 12" Vacuum Hose
(1) Rectangular Nozzle
(1) Tapered Nozzle
(1) Shop Vacuum Hose Adapter with Mounting Tab
(1) Shop Vacuum Canister Adapter



HOSES

2½" HOSE

- 81201** ■
(1) 12" Segment*
- 81202** ■
(2) 12" Segments
- 89220** ■
(20) 12" Segments

*1 Segment = 9 Elements
• Hose Bending Radius = 5.75"



CONNECTORS

3" THIN WALL PVC DWV SCH. 30 ADAPTER

- 81206**
(1) Sch. 30 PVC Adapter
- 89226**
(10) Sch. 30 PVC Adapters



3" SHEET METAL DUCT ADAPTER

- 81207** ■
(1) Sheet Metal Duct Adapter
- 89227** ■
(10) Sheet Metal Duct Adapters



NOZZLES

4½" ROUND NOZZLE

- 81203** ■
(1) Round Nozzle
- 89223** ■
(10) Round Nozzles



6" x 3½" RECTANGULAR NOZZLE

- 81204** ■
(1) Rectangular Nozzle
- 89224**
(10) Rectangular Nozzles



TAPERED OVAL NOZZLE

- 81205** ■
(1) Oval Nozzle
- 89225** ■
(10) Oval Nozzles



VALVES

2½" SLIDE VALVE

- 81208** ■
(1) Slide Valve
- 89228** ■
(10) Slide Valves



ACCESSORIES

SHOP VACUUM HOSE ADAPTER WITH MOUNTING TAB

- 81209** ■
(1) Shop Vacuum Adapter
- 89229** ■
(10) Shop Vacuum Adapters



SHOP VACUUM CANISTER ADAPTER

- 81210** ■
(1) Shop Vacuum Canister Adapter
- 89230** ■
(10) Shop Vacuum Canister Adapters



ANTI-STATIC

2½" HOSE

81301AS ■
(1) 12" Anti-Static Segment*

81302AS ■
(2) 12" Anti-Static Segments

89320AS ■
(20) 12" Anti-Static Segments

*1 Segment = 9 Elements



6" x 3½" RECTANGULAR NOZZLE

81304AS ■
(1) Anti-Static Rectangular Nozzle

89324AS ■
(10) Anti-Static Rectangular Nozzles



TAPERED OVAL NOZZLE

81305AS ■
(1) Anti-Static Oval Nozzle

89325AS ■
(10) Anti-Static Oval Nozzles



2½" SLIDE VALVE

81308AS ■
(1) Anti-Static Slide Valve

89328AS ■
(10) Anti-Static Slide Valves



3" SHEET METAL DUCT ADAPTER

81307AS ■
(1) Anti-Static Metal Duct Adapter

89327AS ■
(10) Anti-Static Metal Duct Adapters



TYPICAL 2 1/2-INCH HOSE CONNECTIONS



3" Thin Wall Sch. 30 DWV PVC Pipe

81206 Loc-Line Sch. 30 DWV PVC Adapter

81201 Loc-Line Vacuum Hose

3" Metal Ducting (28ga)

81207 Loc-Line Sheet Metal Duct Adapter

81201 Loc-Line Vacuum Hose

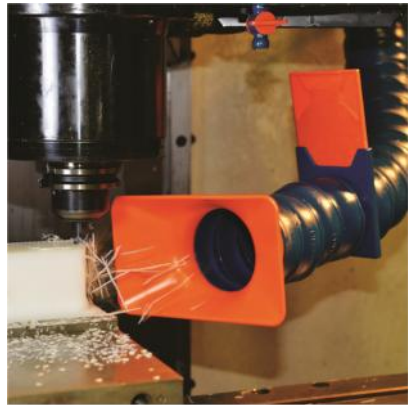



CT HPT NOZZLES

High Pressure Turret (HPT) Nozzles expand the working pressure range to a maximum 1,000 PSI, allowing a higher level of machining while providing the same LOC-LINE® quality and ease of control you've come to expect. Maximum operating temperature is 115° F.

The CT (Compact Turret) style nozzle is designed for tight spaces, from 0 to 1000 PSI.



TECH SPECS

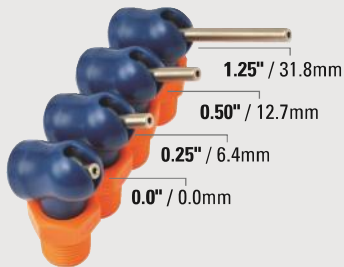

FOUR NOZZLE LENGTHS
Available on both CT and XR Nozzles



FOUR NOZZLE DIAMETERS
Available on both CT and XR Nozzles

1/8" NPT/BSPT THREAD CT STYLE NOZZLES

0.0" NOZZLE LENGTH	0.5" NOZZLE LENGTH
72010 (2) Nozzles, 0.062" \varnothing	72012 (2) Nozzles, 0.062" \varnothing
79010 (10) Nozzles, -BLK -G	79012 (10) Nozzles, -BLK -G
72014 (2) Nozzles, 0.086" \varnothing	72016 (2) Nozzles, 0.086" \varnothing
79014 (10) Nozzles, -BLK -G	79016 (10) Nozzles, -BLK -G
72018 (2) Nozzles, 0.117" \varnothing	72020 (2) Nozzles, 0.117" \varnothing
79018 (10) Nozzles, -BLK -G	79020 (10) Nozzles, -BLK -G
72022 (2) Nozzles, 0.160" \varnothing	72024 (2) Nozzles, 0.160" \varnothing
79022 (10) Nozzles, -BLK -G	79024 (10) Nozzles, -BLK -G
0.25" NOZZLE LENGTH	1.25" NOZZLE LENGTH
72011 (2) Nozzles, 0.062" \varnothing	72013 (2) Nozzles, 0.062" \varnothing
79011 (10) Nozzles, -BLK -G	79013 (10) Nozzles, -BLK -G
72015 (2) Nozzles, 0.086" \varnothing	72017 (2) Nozzles, 0.086" \varnothing
79015 (10) Nozzles, -BLK -G	79017 (10) Nozzles, -BLK -G
72019 (2) Nozzles, 0.117" \varnothing	72021 (2) Nozzles, 0.117" \varnothing
79019 (10) Nozzles, -BLK -G	79021 (10) Nozzles, -BLK -G
72023 (2) Nozzles, 0.160" \varnothing	72025 (2) Nozzles, 0.160" \varnothing
79023 (10) Nozzles, -BLK -G	79025 (10) Nozzles, -BLK -G

1/4" NPT/BSPT THREAD CT STYLE NOZZLES

0.0" NOZZLE LENGTH	0.5" NOZZLE LENGTH
72060 (2) Nozzles, 0.062" \varnothing	72062 (2) Nozzles, 0.062" \varnothing
79060 (10) Nozzles, -BLK -G	79062 (10) Nozzles, -BLK -G
72064 (2) Nozzles, 0.086" \varnothing	72066 (2) Nozzles, 0.086" \varnothing
79064 (10) Nozzles, -BLK -G	79066 (10) Nozzles, -BLK -G
72068 (2) Nozzles, 0.117" \varnothing	72070 (2) Nozzles, 0.117" \varnothing
79068 (10) Nozzles, -BLK -G	79070 (10) Nozzles, -BLK -G
72072 (2) Nozzles, 0.160" \varnothing	72074 (2) Nozzles, 0.160" \varnothing
79072 (10) Nozzles, -BLK -G	79074 (10) Nozzles, -BLK -G
0.25" NOZZLE LENGTH	1.25" NOZZLE LENGTH
72061 (2) Nozzles, 0.062" \varnothing	72063 (2) Nozzles, 0.062" \varnothing
79061 (10) Nozzles, -BLK -G	79063 (10) Nozzles, -BLK -G
72065 (2) Nozzles, 0.086" \varnothing	72067 (2) Nozzles, 0.086" \varnothing
79065 (10) Nozzles, -BLK -G	79067 (10) Nozzles, -BLK -G
72069 (2) Nozzles, 0.117" \varnothing	72071 (2) Nozzles, 0.117" \varnothing
79069 (10) Nozzles, -BLK -G	79071 (10) Nozzles, -BLK -G
72073 (2) Nozzles, 0.160" \varnothing	72075 (2) Nozzles, 0.160" \varnothing
79073 (10) Nozzles, -BLK -G	79075 (10) Nozzles, -BLK -G



XR HPT NOZZLES

LOC-LINE®

The **XR** (Extended Rotation) style nozzle features a wide nozzle swing and the ability to aim coolant below the horizontal plane, from 0 to 1000 PSI.



1/8" NPT/BSPT THREAD XR STYLE NOZZLES

0.0" NOZZLE LENGTH

72040	(2) Nozzles, 0.062" \varnothing	●
79040	(10) -BLK -G Nozzles	●
72044	(2) Nozzles, 0.086" \varnothing	●
79044	(10) -BLK -G Nozzles	●
72048	(2) Nozzles, 0.117" \varnothing	○
79048	(10) -BLK -G Nozzles	○
72052	(2) Nozzles, 0.160" \varnothing	○
79052	(10) -BLK -G Nozzles	○

0.5" NOZZLE LENGTH

72042	(2) Nozzles, 0.062" \varnothing	●
79042	(10) -BLK -G Nozzles	●
72046	(2) Nozzles, 0.086" \varnothing	●
79046	(10) -BLK -G Nozzles	●
72050	(2) Nozzles, 0.117" \varnothing	○
79050	(10) -BLK -G Nozzles	○
72054	(2) Nozzles, 0.160" \varnothing	○
79054	(10) -BLK -G Nozzles	○

0.25" NOZZLE LENGTH

72041	(2) Nozzles, 0.062" \varnothing	●
79041	(10) -BLK -G Nozzles	●
72045	(2) Nozzles, 0.086" \varnothing	●
79045	(10) -BLK -G Nozzles	●
72049	(2) Nozzles, 0.117" \varnothing	○
79049	(10) -BLK -G Nozzles	○
72053	(2) Nozzles, 0.160" \varnothing	○
79053	(10) -BLK -G Nozzles	○

1.25" NOZZLE LENGTH

72043	(2) Nozzles, 0.062" \varnothing	●
79043	(10) -BLK -G Nozzles	●
72047	(2) Nozzles, 0.086" \varnothing	●
79047	(10) -BLK -G Nozzles	●
72051	(2) Nozzles, 0.117" \varnothing	○
79051	(10) -BLK -G Nozzles	○
72055	(2) Nozzles, 0.160" \varnothing	○
79055	(10) -BLK -G Nozzles	○

1/4" NPT/BSPT THREAD XR STYLE NOZZLES

0.0" NOZZLE LENGTH

72080	(2) Nozzles, 0.062" \varnothing	●
79080	(10) -BLK -G Nozzles	●
72084	(2) Nozzles, 0.086" \varnothing	●
79084	(10) -BLK -G Nozzles	●
72088	(2) Nozzles, 0.117" \varnothing	○
79088	(10) -BLK -G Nozzles	○
72092	(2) Nozzles, 0.160" \varnothing	○
79092	(10) -BLK -G Nozzles	○

0.5" NOZZLE LENGTH

72082	(2) Nozzles, 0.062" \varnothing	●
79082	(10) -BLK -G Nozzles	●
72086	(2) Nozzles, 0.086" \varnothing	●
79086	(10) -BLK -G Nozzles	●
72090	(2) Nozzles, 0.117" \varnothing	○
79090	(10) -BLK -G Nozzles	○
72094	(2) Nozzles, 0.160" \varnothing	○
79094	(10) -BLK -G Nozzles	○

0.25" NOZZLE LENGTH

72081	(2) Nozzles, 0.062" \varnothing	●
79081	(10) -BLK -G Nozzles	●
72085	(2) Nozzles, 0.086" \varnothing	●
79085	(10) -BLK -G Nozzles	●
72089	(2) Nozzles, 0.117" \varnothing	○
79089	(10) -BLK -G Nozzles	○
72093	(2) Nozzles, 0.160" \varnothing	○
79093	(10) -BLK -G Nozzles	○

1.25" NOZZLE LENGTH

72083	(2) Nozzles, 0.062" \varnothing	●
79083	(10) -BLK -G Nozzles	●
72087	(2) Nozzles, 0.086" \varnothing	●
79087	(10) -BLK -G Nozzles	●
72091	(2) Nozzles, 0.117" \varnothing	○
79091	(10) -BLK -G Nozzles	○
72095	(2) Nozzles, 0.160" \varnothing	○
79095	(10) -BLK -G Nozzles	○

NOZZLE ADJUSTMENT LEVER

ADJUSTMENT LEVERS

72000 (2) Adjustment Levers
79000 (10) Adjustment Levers

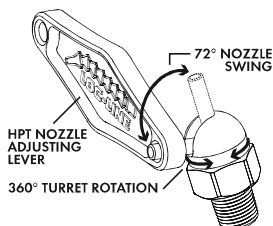

CT NOZZLE ADJUSTMENT

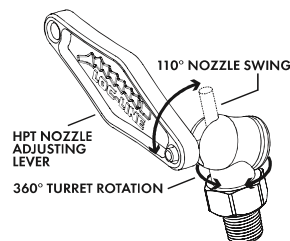

XR NOZZLE ADJUSTMENT

ACID RESISTANT SYSTEM

1/4" ACID RESISTANT

1/4" ACID RESISTANT HOSE KIT

- 45463** ■
 (2) 5/4" Long Segments
 (1) 1/4" Nozzle
 (1) 1/8" Nozzle
 (1) 1/16" Nozzle
 (1) 1/4" NPT Connector
 (1) 1/8" NPT Connector

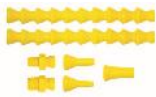

1/4" ACID RESISTANT HOSE

- 45401** ■
 (2) 5/4" Long Segments
46420 ■
 (55) Segments, Bulk 25-ft
46419 ■
 (1) 5 ft Coil
46421 ■
 (1) 50 ft Coil



1/16" ACID RESISTANT NOZZLE

- 45402** ■
 (4) Round Nozzles
46422 ■
 (50) Round Nozzles



1/8" ACID RESISTANT NOZZLE

- 45403** ■
 (4) Round Nozzles
46423 ■
 (50) Round Nozzles



1/4" ACID RESISTANT NOZZLE

- 45404** ■
 (4) Round Nozzles
46424 ■
 (50) Round Nozzles



1" ACID RESISTANT FLARE NOZZLE

- 45407** ■
 (2) Flare Nozzles
46427 ■
 (20) Flare Nozzles



1/8" ACID RESISTANT NPT CONNECTOR

- 45405** ■
 (4) NPT Connectors
46425 ■
 (50) NPT Connectors



1/4" ACID RESISTANT NPT CONNECTOR

- 45406** ■
 (4) NPT Connectors
46426 ■
 (50) NPT Connectors



1/4" ACID RESISTANT Y FITTING

- 45408** ■
 (2) Y Fittings
46428 ■
 (20) Y Fittings



1/4" ACID RESISTANT DOUBLE SOCKET

- 45409** ■
 (4) Double Sockets
46429 ■
 (20) Double Sockets



1/4" SOCKET X 1/8" FNPT ACID RESISTANT

- 45411** ■
 (4) 1/4" Socket X 1/8" FNPT
46431 ■
 (20) 1/4" Socket X 1/8" FNPT



1/4" ACID RESISTANT ELBOW FITTING

- 45415** ■
 (2) Elbow Fittings
46435 ■
 (20) Elbow Fittings



1/4" ACID RESISTANT T FITTING

- 45416** ■
 (2) T Fittings
46436 ■
 (20) T Fittings



1/4" ACID RESISTANT SWIVEL NOZZLE 40

- 45481** ■
 (2) Swivel Nozzles
46449 ■
 (20) Swivel Nozzles



1/4" ACID RESISTANT SWIVEL NOZZLE 60

- 45482** ■
 (2) Swivel Nozzles
46450 ■
 (20) Swivel Nozzles



• Loc-Line® Acid Resistant Hose is excellent for rinsing cycles in plating operations.

• Acid environments won't corrode the Loc-Line® Acid Resistant Hose because of its polyester composition.
CAUTION: Loc-Line® Acid Resistant Hose is not intended for conveying acids or high pressure applications.



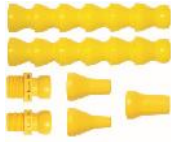

1/2" ACID RESISTANT

1/2" ACID RESISTANT HOSE KIT

- 56863**  (2) 5 1/2" Long Segments
- (1) 1/4" Round Nozzle
- (1) 3/8" Round Nozzle
- (1) 1/2" Round Nozzle
- (1) 3/8" NPT Connector
- (1) 1/2" NPT Connector





1/2" ACID RESISTANT HOSE

- 56801**  (2) 5 1/2" Long Segments
- 57860**  (59) Segments, Bulk 25 ft
- 57859**  (1) 5 ft Coil
- 57861**  (1) 50 ft Coil





1/4" ACID RESISTANT NOZZLE

- 56806**  (4) Round Nozzles
- 57866**  (50) Round Nozzles





3/8" ACID RESISTANT NOZZLE

- 56802**  (4) Round Nozzles
- 57862**  (50) Round Nozzles



1/2" ACID RESISTANT NOZZLE

- 56803**  (4) Round Nozzles
- 57863**  (50) Round Nozzles



3/8" ACID RESISTANT NPT

- 56804**  (4) NPT Connectors
- 57864**  (50) NPT Connectors





1/2" ACID RESISTANT NPT

- 56805**  (4) NPT Connectors
- 57865**  (50) NPT Connectors





1 1/4" ACID RESISTANT FLARE NOZZLE

- 56807**  (2) Flare Nozzles
- 57867**  (20) Flare Nozzles





1/2" ACID RESISTANT Y FITTING

- 56808**  (2) Y Fittings
- 57868**  (20) Y Fittings



1/2" TO 1/4" ACID RESISTANT Y REDUCER

- 56822**  (2) Y Reducers
- 57870**  (20) Reducers



1/2" TO 1/4" ACID RESISTANT ADAPTER

- 56821**  (2) Adapters
- 57869**  (20) Adapters





1/2" ACID RESISTANT ELBOW FITTING

- 56824**  (2) Elbow Fittings
- 57874**  (20) Elbow Fittings



1/2" ACID RESISTANT T FITTING

- 56825**  (2) T Fittings
- 57875**  (20) T Fittings



1/2" DOUBLE SOCKET



- 56811**  (4) Double Sockets
- 57872**  (20) Double Sockets



TEFEN™ FITTINGS



Tefen™ products change male fittings to female threads. Tefen products are made in Israel.

1/8" FEMALE PIPE COUPLING

- 40656**  (4) Female Pipe Couplings
- 41756**  (20) Female Pipe Couplings





1/4" FEMALE PIPE COUPLING

- 40657**  (4) Female Pipe Couplings
- 41757**  (20) Female Pipe Couplings





3/8" FEMALE PIPE COUPLING

- 50660**  (4) Female Pipe Couplings
- 51760**  (20) Female Pipe Couplings





1/2" FEMALE PIPE COUPLING

- 50661**  (4) Female Pipe Couplings
- 51761**  (20) Female Pipe Couplings





1/4" PIPE PLUG

- 40654**  (4) Pipe Plug
- 41754**  (20) Pipe Plug





1/4" TO 1/8" FEMALE PIPE REDUCER

- 40655**  (4) Female Pipe Reducers
- 41755**  (20) Female Pipe Reducers





3/8" TO 1/4" FEMALE PIPE REDUCER

- 50658**  (4) Female Pipe Reducers
- 51758**  (20) Female Pipe Reducers



1/2" TO 1/4" FEMALE PIPE REDUCER

- 50659**  (4) Female Pipe Reducers
- 51759**  (20) Female Pipe Reducers



TECHNICAL INFORMATION

IDENTIFYING LOC-LINE SYSTEMS



MEASURING LOC-LINE

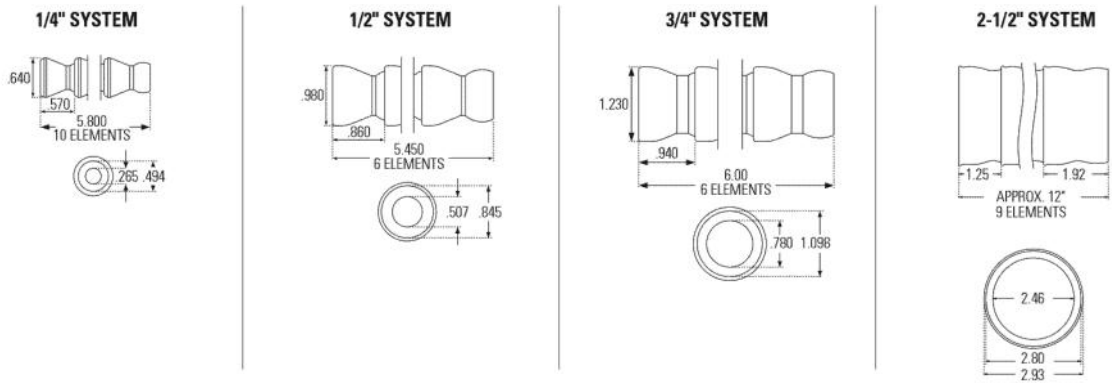

MINIMUM HOSE BENDING DIAMETER

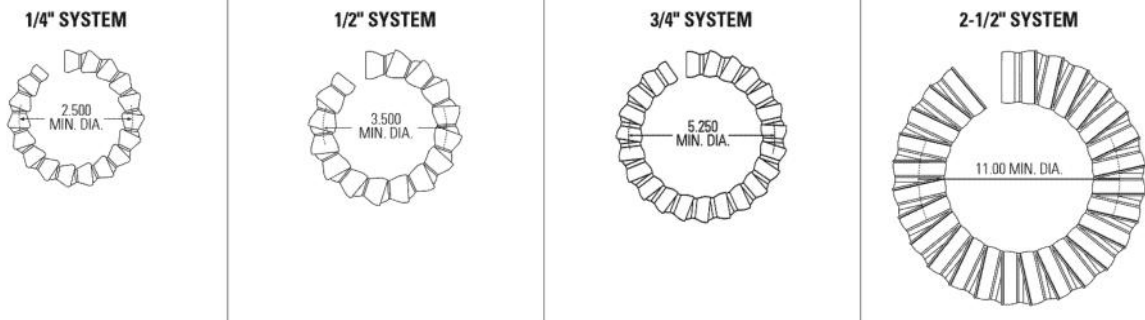

LINE PRESSURE AND FLOW RATES

1/4" SYSTEM

	LINE PRESSURE	FLOW RATE
Standard	50 PSI	250 gal/hr
w/ clamps	up to 110 PSI*	

*Assumes use of element clamps on all joints and fully tightened.

Please note that all applications have variables and conditions that will affect the maximum hose pressures. Testing is always recommended whenever possible.

1/2" SYSTEM

	LINE PRESSURE	FLOW RATE
Standard	30 PSI	478 gal/hr
w/ clamps	up to 75 PSI*	

*Assumes use of element clamps on all joints and fully tightened.

3/4" SYSTEM

	LINE PRESSURE	FLOW RATE
Standard	20 PSI	1,140 gal/hr
w/ clamps	up to 50 PSI*	

*Assumes use of element clamps on all joints and fully tightened.

Additional flow rate information and graphs can be viewed at www.loc-line.com

MATERIAL SPECIFICATIONS

COMMON COMPATIBILITY WITH LOC-LINE ACETAL PRODUCTS

■ BLUE ■ ORANGE ■ BLACK ■ GREY □ WHITE

Yes	Acetone
No	Acids
Yes	Alcohol, Ethyl
No	Ammonium Hydroxide, Strong
No	Bases, Strong
Yes	Commercial Dish Detergents
Yes	Gasoline
Yes	Greases
No	Hypochlorite Ion Solutions
Yes	Lacquer Solvents
Yes	Oils
Yes	Sodium Hydroxide
No	Sodium Hypochlorite

ACETAL TEMPERATURE DATA

■ BLUE ■ ORANGE ■ BLACK ■ GREY □ WHITE

Melting point: 329° F
Maximum operating temperature: 170° F

TEMPERATURE DATA - HPT NOZZLE

Maximum operating temperature: 115° F

ACETAL ANTI-STATIC ELECTRICAL PROPERTIES

■ BLACK (2½" System)

Surface Resistivity: 1.000E3 Ohm
Volume Resistivity: <6.000E2 Ohm-cm

COMMON COMPATIBILITY WITH LOC-LINE POLYESTER PRODUCTS

■ YELLOW ACID RESISTANT

No	Acetone
Yes	Acids, (Less than 150° F)
No	Acids, (Greater than 150° F)
Yes	Alcohols
Yes	Aromatic Solvents
No	Chlorinated Hydrocarbon
No	Bases, Strong
No	Ethyl Acetate
Yes	Gasoline
Yes	Greases
Yes	Hydrocarbons
Yes	Oils
Yes	Salt Solutions

TEMPERATURE DATA - POLYESTER

■ YELLOW ACID RESISTANT

Melting point: 475° F
Maximum operating temperature: 170° F

REGULATORY INFORMATION

FDA – Acetal Copolymer meets the requirements for food contact in accordance to the rules in 21CFR 177.2470. All color pigments are used at the recommended let-down ratio that meet 21CFR 178.3297.

NSF – Acetal Copolymer meets the Standards 14, 51 and 61 meet plumbing items in contact with potable water.

Loc-Line products are REACH compliant and RoHS compliant. Loc-Line products are free from Ozone depleting chemicals.

Lockwood Products, Inc. does not produce Loc-Line in a FDA certified facility. Nor does Lockwood Products, Inc. warrant any particular application.

